

# OB/GYN Instruments

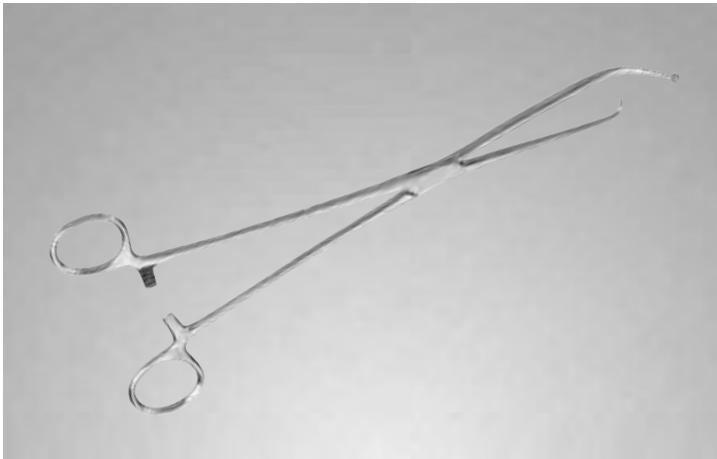
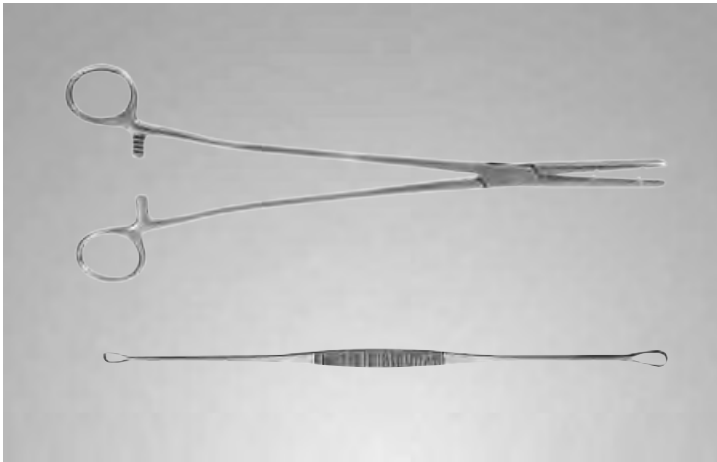

## Specula

Spéculum  
Spekula  
Speculum  
Espéculos  
Espéculos  
檢鏡

### GRAVES Vaginal Specula

Mirror finish.



#### GL10

Small. Blade 3in x 3/4in wide  
(7.6cm x 1.9cm).

#### GL11

Medium. Blade 4in x 1-3/8in wide  
(10.2cm x 3.5cm).

#### GL12

Large. Blade 4-1/2in x 1-3/8in wide  
(11.5cm x 3.5cm).

#### GL14

Extra-large. Blade 6in x 1-1/2in (15.2cm x 3.8cm).

#### GL15

Double XL. Blade 7in x 1-1/2in (17.8cm x 3.8cm).

### GRAVES Open Side Vaginal Speculum

Mirror finish.



#### GL25

Medium, with ratchet lock.  
4in x 1-5/16in wide  
(10.2cm x 3.4cm).

### GRAVES Improved Vaginal Specula

Mirror finish.



#### GL16

Small. 3in x 3/4in wide  
(7.6cm x 1.9cm).

#### GL17

Medium. 4in x 1-3/8in wide  
(10.2cm x 3.5cm).

#### GL18

Large. 4-1/4in x 1-5/16in wide  
(10.8cm x 3.5cm).

### GRAVES Speculum with Suction

With permanent smoke evacuation tube.



#### GL20

Large. Blade  
4-1/2in x 1-3/8in wide  
(11.4cm x 3.5cm).

**PEDERSON Vaginal Specula**

Mirror finish.

**GL30**Small. 3in x 1/2in wide  
(7.6cm x 1.3cm).◆ **GL31**Medium. 4in x 7/8in wide  
(10.2cm x 2.2cm).**GL32**Large. 4-1/2in x 1-1/16in wide  
(11.4cm x 2.6cm).**PETERSON Vaginal Speculum**

With permanent smoke evacuation tube.

**GL33**Large. Blade  
4-3/4in x 1in wide  
(12.1cm x 2.5cm).**GUTTMANN Vaginal Specula**

Matte and Mirror finish.

**GL210**Solid center blade.  
3-1/2in x 1-3/16in wide  
(8.9cm x 3cm).**GL220**Fenestrated center blade.  
3-1/2in x 1-3/16in wide  
(8.9cm x 3cm).**HUFFMAN-GRAVES Vaginal Speculum****GL34**4-5/16in x 9/16in wide  
(11cm x 1.4cm).

## Specula

Spéculum  
Spekula  
Speculum  
Espéculos  
Espéculos  
檢鏡

### KAHN-GRAVES Vaginal Speculum

Mirror finish.

**GL55**

4-5/16in x 1-3/8in wide (11cm x 3.5cm).



### Vaginal Specula

Single-bladed.

Overall length 9in (23cm).

**GL40**

Medium.

**GL42**

Large.



### HUFFMAN Infant Vaginoscope

Partially Chrome Plated.

**GL170**

Working length  
2-9/16in (6.5cm).



### KOGAN Endospeculum

Fenestrated blades and finger rings bent outward in opposite directions. Spring-closed blades open when finger rings are pressed together. Blade length 7/8in (21mm). With gauge.

**GL750**

Overall length  
9-3/4in (24.8cm).



**GARRIGUE Vaginal Speculum**

Weighted. Mirror finish.

◆ **GL250**Blade 3in x 1-9/16in wide  
(7.6cm x 4cm).**AUVARD Vaginal Specula**

Weighted. Mirror finish.

◆ **GL258**Blade 3-3/8in x 1-1/4in wide  
(8.6cm x 3.2cm).◆ **GL259**Blade 4in x 1-1/4in wide  
(10.2cm x 3.2cm).**STEINER Speculum**

Weighted. Mirror finish.

◆ **GL260**Blade 5-1/2in x 1-1/4in  
(14.1cm x 3.2cm) wide.**TAUBER Vaginal Spatula**◆ **GL450**Blade 3-1/2in x 1-3/8in wide  
(8.9cm x 3.5cm). Overall length  
9-1/4in (23.5cm).

## Specula/Retractors

Spéculum/Écarteurs  
 Spekula/Wundspreizer/Retraktoren  
 Speculum/Divaricatori  
 Espéculos/Separadores  
 Espéculos/Retratores  
 検鏡/リトラクター

### BREISKY-NAVRATIL Vaginal Specula

Mirror and Satin finish. Overall length 12in (30.5cm).

#### GL460

Blade 3-15/16in x 3/4in wide (10cm x 1.8cm).

#### ◆ GL461

Blade 3-15/16in x 1in wide (10cm x 2.5cm).

#### GL462

Blade 3-15/16in x 1-3/16in wide (10cm x 3cm).

#### GL463

Blade 4-3/8in x 1-3/8in wide (11.1cm x 3.5cm).

#### GL464

Blade 3-15/16in x 1-1/2in wide (10cm x 3.8cm).

#### GL465

Blade 4-3/4in x 1-3/16in wide (12cm x 3cm).

#### GL466

Blade 5-1/8in x 1-3/8in wide (13cm x 3.5cm).

#### GL467

Blade 5-1/2in x 1-3/8in wide (14cm x 3.5cm).

#### ◆ GL469

Blade 6-1/4in x 1-3/8in wide (16cm x 3.5cm).

#### ◆ GL470

Blade 6-11/16in x 1in wide (17cm x 2.5cm).



### MATZENAUER Vaginal Speculum

Mirror and Satin finish.

#### GL475

Blade 4-5/16in x 1in wide  
 (11cm x 2.5cm).  
 Overall length  
 12-3/8in (31.5cm).



### MATZENAUER Vaginal Specula

#### GL486

Blade 4-3/4in x 1-1/2in  
 wide (12cm x 3.8cm).



### SIMS Vaginal Specula

Double-ended.

#### GL300

Blade  
 1in x 1-1/16in wide  
 (2.5cm x 2.6cm).

#### GL301

Blade  
 1-1/16in x 1-3/16in wide  
 (2.6cm x 3cm).

#### GL302

Blade  
 1-3/16in x 1-7/16in wide  
 (3cm x 3.6cm).



### EASTMAN Vaginal Retractors

Overall length 6-7/8in (17.5cm).

#### GL420

Small. Blade  
 3in x 1-1/2in wide  
 (7.6cm x 3.8cm).

#### GL421

Medium. Blade  
 3-1/2in x 1-1/2in wide  
 (8.9cm x 3.8cm).

#### GL422

Large. Blade  
 4in x 1-1/2in wide  
 (10.2cm x 3.8cm).

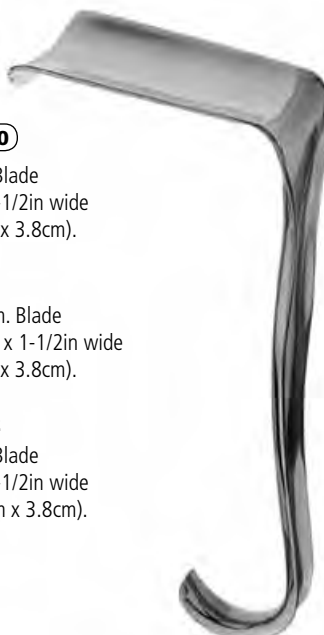

### DOYEN Vaginal Retractors

#### GL431

Blade 3-3/4in x 1-3/4in wide  
 (9.5cm x 4.7cm). Overall length  
 8-3/4in (22.0cm).

#### GL432

Blade 5in x 1-3/4in wide  
 (12.9cm x 4.4cm). Overall length  
 8-1/2in (21.6cm).

#### GL434

Blade 4in x 2-3/8in wide  
 (9.8cm x 6cm). Overall length  
 9-1/4in (23.4cm).

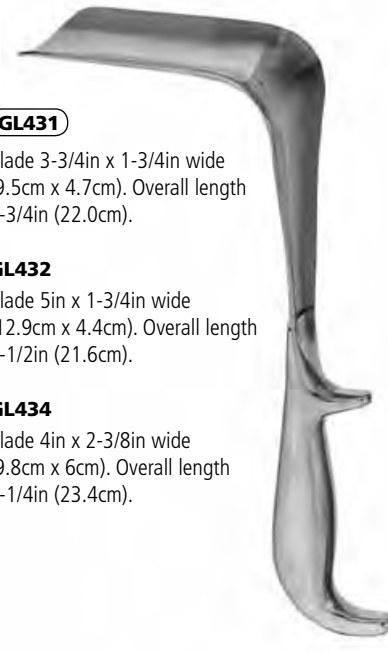

**DE LEE Universal Retractor**◆ **GL480**

Blade 2-3/4in x 2in wide  
(7cm x 5.1cm). Overall length  
9-1/2in (24.1cm).

**DE LEE Corner Retractors**

Blade 2-3/4in x 2in wide.  
Overall length 10in (25.5cm).

**GL481**

Right.

**GL482**

Left.

**JACKSON Vaginal Retractors**

Overall length 6-7/8in (17.5cm).

**GL410**

Small. Blade 3in x 1-1/2in wide (7.6cm x 3.8cm).

**GL411**

Medium. Blade 3-1/2in x 1-1/2in wide (8.9cm x 3.8cm).

**GL412**

Large. Blade 4in x 1-1/2in wide (10.2cm x 3.8cm).

**SIMS Vaginal Retractors****GL310**

Blade 2-3/4in x 1in wide (7cm x 2.5cm).

**GL311**

Blade 3in x 1-1/4in wide (7.6cm x 3.2cm).

**GL312**

Blade 3-1/2in x 1-1/2in wide (8.9cm x 3.8cm).





## Retractors

Écarteurs  
Wundspreizer/Retraktoren  
Divaricatori  
Separadores  
Retratores  
リトラクター

### KELLY-SIMS Vaginal Retractor

#### GL320

Blade 2-1/4in x 1in wide  
(5.7cm x 2.5cm).



### HEANEY-SIMON Retractor

#### GL350

Blade 4-1/2in x 1in wide  
(11.5cm x 2.5cm). Overall length  
10-1/2in (26.7cm).



### HEANEY Retractors

Overall length 6-3/4in (17.1cm).

#### GL390

Small. Blade 1-3/4in x 1in wide  
(4.4cm x 2.5cm).

#### GL391

Medium. Blade 2-7/8in x 1-1/8in wide  
(7.3cm x 2.8cm).

#### GL392

Large. Blade 3-1/4in x 1-1/8in wide  
(8.3cm x 2.8cm).



### GLENNER Retractor

#### GL360

Blade 5-1/4in x 1in wide  
(13.3cm x 2.5cm). Overall length  
10-5/8in (27cm).





Écarteurs  
Wundspreizer/Retraktoren  
Divaricatori  
Separadores  
Retratores  
リトラクター

**Lateral Wall Retractors**

For use inside vaginal speculum.  
Open shanks.

**GL440**

Blade length 2-1/2in (6.4cm).  
Overall length 9in (23cm).

**GL442**

Blade length 3-1/2in (8.9cm).  
Overall length 10in (25cm).

**GL444**

Blade length 4-1/2in (11.4cm).  
Overall length 11in (28cm).

**Lateral Wall Retractor**

For use inside vaginal speculum.  
Closed shanks.

**GL446**

Blade length 2-1/2in (6.4cm).

**Redundant Wall Retractors**

For use outside vaginal speculum.  
Overall length 7in (18cm).

**GL448**

Blade length 3in (7.6cm).

**GL449**

Blade length 5in (12.6cm).

**RIGBY Vaginal Retractor**

Smooth, solid, self-retaining blades.  
With ratchet lock.

**GL560**

Overall length  
7-1/2in (19cm).



## Retractors

Écarteurs  
Wundspreizer/Retraktoren  
Divaricatori  
Separadores  
Retratores  
リトラクター

### GUTTMANN Obstetrical Retractor

Synchronous three-way movement.  
Self-retaining.

**GL570**

Blade 2-3/4in x 9/16in wide  
(7cm x 1.5cm).



### O'SULLIVAN-O'CONNOR Vaginal Speculum

**GL200**

Interchangeable center blades:  
One each 3-1/2in x 1-3/4in wide  
(9cm x 4.4cm).  
One each 3-1/2in x 1-1/4in wide  
(9cm x 3.2cm).  
One each 1-3/4in x 3/4in wide  
(4.4cm x 1.9cm).  
Permanent side blades:  
Two each 1-3/4in x 3/8in wide  
(4.4cm x 1cm).



### SMITH Vaginal Retractor

Self-retaining. The angle and counter-traction of the blades serve to hold the retractor securely in place.



**GL530**

Ring is 9in (23cm) in diameter; three identical right-angled retractors with blades 4in x 1-3/4in wide (10.2cm x 4.4cm).  
Blades have 8in (20.3cm) handles.

### V. Mueller Instrument Detergents

To assist with the care and handling of your instruments, CareFusion offers you a full line of cleaning and decontamination products detailed in the Genesis Sterilization Containers and Instrument Processing Supplies section of this armamentarium.

Aiguilles/Crochets  
Nadeln/Haken  
Aghi/Uncini  
Agujas/Ganchos  
Agulhas/Ganchos  
針/フック

**DESCHAMPS-NAVRATIL Ligature Needles**

Mirror and Satin finish.  
Overall length  
8-11/16in (22cm).

**GL1220**

Curved left for  
the right hand.

**GL1222**

Curved right for  
the left hand.



**NICHOLS-DESCHAMPS-NAVRATIL Ligature Needles**

Overall length  
11-7/16in (29cm).

**GL1223**

Curved left for  
the right hand.

**GL1224**

Curved right for  
the left hand.



**BRAUN Ligature Carrier**

Mirror and Satin finish.

**GL1240**

Right-angle hook.  
Overall length  
9-1/2in (24.1cm).



**PEREYRA Improved Ligature Cannula**

Mirror finish.

**GL3750**

Overall length  
10-3/4in (27.3cm).



**EMMETT Tenaculum Hooks**

Overall length 9in (22.9cm).



**GL800**

Style No. 1. Sharp.



**GL802**

Style No. 3. Sharp.



**GL803-001**

Style No. 4. Blunt.



**GL800-001**

Style No. 1. Blunt.



**GL802-001**

Style No. 3. Blunt.



**GL804**

Style No. 5. Sharp.



**GL801**

Style No. 2. Sharp.



**GL803**

Style No. 4. Sharp.



**GL804-001**

Style No. 5. Blunt.

**IUD Removal Hook**

Malleable.  
Overall length  
10-1/4in (26cm).

**GL1875**



OB/GYN

**Needle Holders/Scissors**

Porte-aiguilles/Ciseaux  
 Nadelhalter/Scheren  
 Porta-ago/Forbici  
 Sostenes de agujas/Tijeras  
 Porta-agulhas/Tesoura  
 針ホルダー/鉋

**BOZEMAN-WERTHEIM  
 Needle Holder**

Bayonet.



**SU16130**

Overall length  
 9-1/2in (24.1cm).



**KELLY Uterine Scissors**

Short blades. Sharp/Sharp. Mirror finish.  
 Overall length 6-1/4in (15.9cm).

**GL3420**

Straight.

**GL3421**

Curved.



**SIMS Uterine Scissors**

Straight. Mirror finish.  
 Overall length 8in (20.3cm).

**GL3400**

Sharp/Blunt.

**GL3401**

Blunt/Blunt.

**GL3402**

Sharp/Sharp.

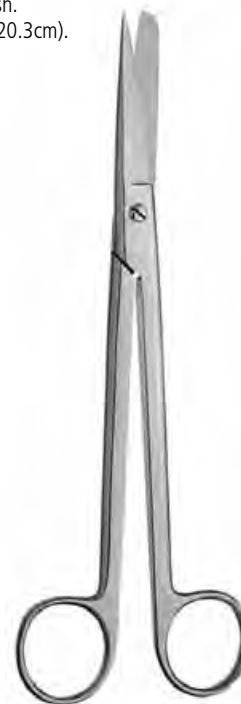

**SIMS Uterine Scissors**

Curved. Mirror finish.  
 Overall length 8in (20.3cm).

**GL3405**

Sharp/Blunt.

**GL3406**

Blunt/Blunt.

**GL3407**

Sharp/Sharp.



**Vital® Uterine Scissors**

Stellite® cutting edges.

**GL3450**

Slightly curved blades.  
 Overall length  
 9in (23cm).

**GL3450-001**

Strongly curved blades.  
 Overall length  
 9in (23cm).

**GL3450-002**

Angulated blades.  
 Overall length  
 9in (23cm).

**GL3452**

Slightly curved blades.  
 Overall length  
 10-1/2in (26.5cm).

**GL3452-001**

Strongly curved blades.  
 Overall length  
 10-1/2in (26.5cm).

**GL3452-002**

Angulated blades.  
 Overall length  
 10-1/2in (26.5cm).

**GL3454**

Slightly curved blades.  
 Overall length  
 12in (30cm).

**GL3454-001**

Strongly curved blades.  
 Overall length  
 12in (30cm).

**GL3456**

Slightly curved blades.  
 Overall length  
 14in (35cm).

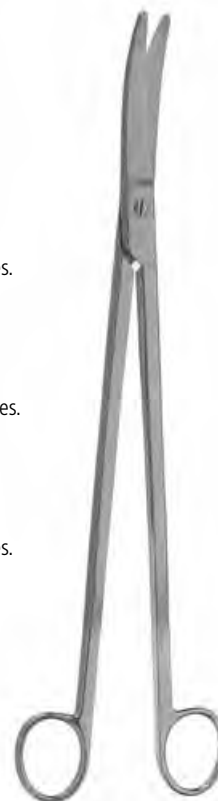

Ciseaux/Forceps  
Scheren/Zangen  
Forbici/Pinze  
Tijeras/Fórceps  
Tesoura/Fórceps  
鉗/鉗子

**BRAUN Episiotomy Scissors**

Angled. Mirror finish.

**GL3500**

Overall length  
5-1/2in (14cm).



**WALDMANN Episiotomy Scissors**

Curved, slight serrations.  
Mirror finish.

**GL3510**

Overall length  
7in (18cm).



**SCHROEDER Episiotomy Scissors**

Heavy. Straight. Sharp/Blunt.  
Mirror finish.

**GL3480**

Overall length  
8-1/4in (21cm).



**AMERICAN Pattern Umbilical Scissors**

Straight.

**GL3550**

Overall length  
4in (10.2cm).



**MOYNIHAN-NAVRATIL Forceps**

Angled.

**GL3260**

Overall length  
7-7/8in (20cm).

**GL3262**

Overall length  
9-1/2in (24cm).

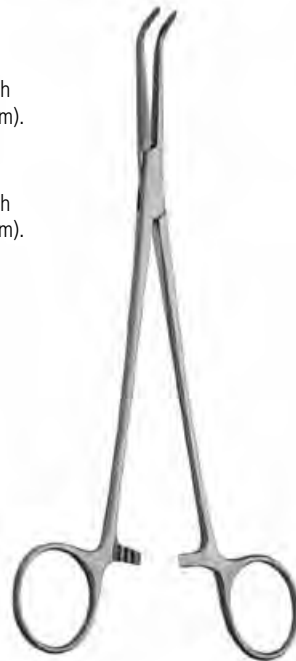

**BOZEMAN Uterine Packing Forceps**

Curved.  
Overall length  
10in (25.4cm).

**GL600**

**GL600-MM**  
Mueller-Mirror®  
finish.



## Forceps

Forceps  
Zangen  
Pinze  
Fórcps  
Fórcps  
鉗子

### DE LEE Uterine Packing Forceps

Curved.

**GL620**

Overall length  
11-1/4in (28.7cm).



### BARRETT Uterine Tenaculum Forceps

Straight.

**GL860**

Overall length  
7-1/8in (18.1cm).



### BRAUN Uterine Tenaculum Forceps

Straight.

◆ **GL850**

Overall length  
9-1/2in (24.1cm).



### DE LEE Cervix Holding Forceps

Straight. Serrated.

**GL680**

Overall length  
9-1/2in (24.1cm).



### GUTGLASS Cervix Hemostatic Forceps

Straight, serrated.

**GL685**

Overall length  
9-3/4in (24.5cm).



### BIERER Ovum Forceps

Overall length 11in (27.9cm).

**GL5712**

Jaws 12mm wide.  
Serrated fine jaws.  
Without ratchet.

**GL5714**

Jaws 14mm wide.  
Serrated fine jaws.  
Without ratchet.

**GL5716**

Jaws 16mm wide.  
Large teeth.  
With ratchet.

**GL5719**

Jaws 19mm wide.  
Large teeth.  
With ratchet.

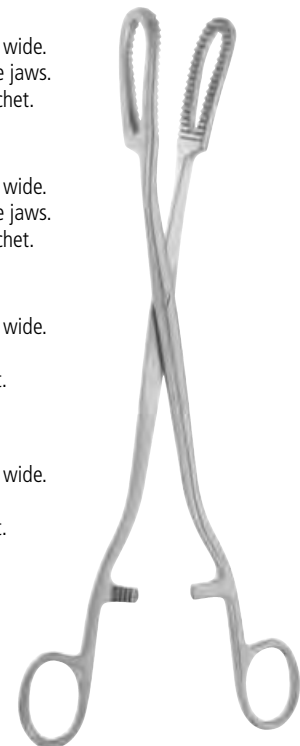

**SKENE Uterine Tenaculum Forceps**

Curved on side.

**GL900**

Overall length  
9-5/8in (24.4cm).



**GORDON Uterine Vulsellum Forceps**

Straight. 3 x 3 prongs.

**GL1070**

Overall length  
8-3/4in (22.2cm).



**JACOB Uterine Vulsellum Forceps**

2 x 2 teeth. Overall length 8-1/4in (21cm).

**GL950**

Straight.

**GL952**

Curved on side.



**HENROTIN Uterine Vulsellum Forceps**

Straight. 2 x 3 teeth.

**GL970**

Overall length  
8-1/4in (21cm).



**SOMERS Uterine Elevating Forceps**

Curved, serrated, fenestrated jaws. Mirror finish.

**GL3010**

Overall length  
8-3/4in (22.2cm).





**Forceps**

Forceps  
Zangen  
Pinze  
Fórceps  
Fórceps  
鉗子

**BUXTON Uterine Clamp**

Swivel jaws.

**GL3025**

Overall length  
9-3/4in (24.8cm).



**HULKA-KENWICK Uterine Elevating and Manipulating Forceps**

◆ **GL3030**

Overall length  
10-3/4in (27.3cm).



**HULKA Single Tooth Tenaculum Forceps**

Overall length  
11-1/2in (29.2cm).

**GL3035**



**COLLIER-ANDERSON Clamps**

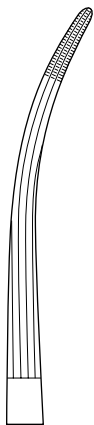

**GL3292**

Overall length  
14in (35.6cm).



*Customer Support*

Our highly trained, centralized V. Mueller customer support team is available to take your calls from 7:00 a.m. to 6:00 p.m. (CST), M-F. This group is dedicated to providing a full range of support services, including:

- Order placement
- Order inquiries
- Delivery information
- Product information
- Pricing inquiries

If we can be of assistance, please call us at **800.323.9088**.

**ROCHESTER-CARMALT Hysterectomy Forceps**

Longitudinal serrations.

**GL3220**

Straight.  
Overall length  
9in (22.9cm).

**GL3221**

Straight.  
Overall length  
10-1/8in (25.8cm).

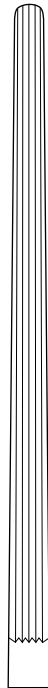

**GL3230**

Curved.  
Overall length  
9in (22.9cm).

**GL3231**

Curved.  
Overall length  
10in (25.4cm).

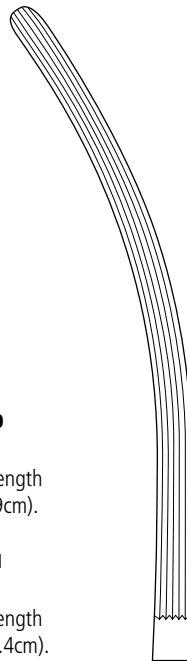

**HEANEY Hysterectomy Forceps**

Curved, biased serrations.

◆ **GL3100**

Overall length  
8-1/4in (21cm).

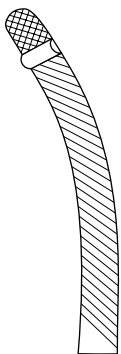

**HEANEY-REZEK Hysterectomy Forceps**

Straight, criss-cross serrations.

**GL3101**

Overall length  
8-1/4in (21cm).



**Forceps/Clamps**

Forceps/Clamps  
Zangen/Klemmen  
Pinze/Morse  
Fórceps/Pinças  
Fórceps/Pinças  
鉗子/クランプ

**HEANEY-KANTER Hysterectomy Forceps**

Curved. Additional wide tooth.

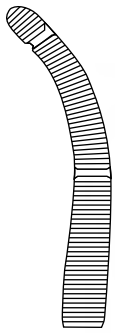

**GL3110**

Overall length 8-1/4in (21cm).

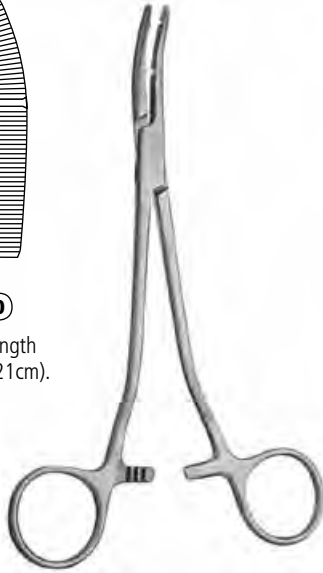

**HEANEY-BALLENTINE Hysterectomy Forceps**

Curved, longitudinal grooves.

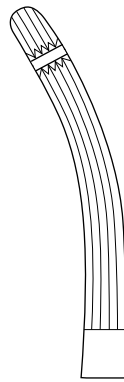

◆ **GL3120**

Overall length 8-1/4in (21cm).

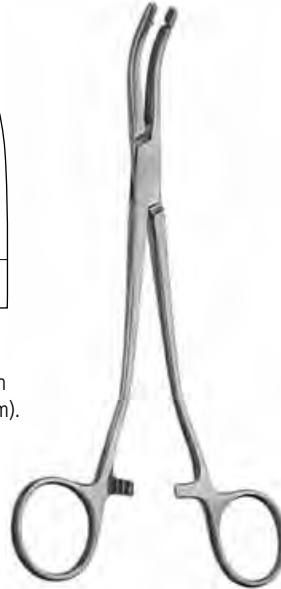

**BALLENTINE Hysterectomy Forceps**

Straight, longitudinal grooves.

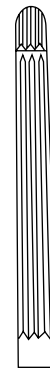

◆ **GL3121**

Overall length 8-1/4in (21cm).



**BALLENTINE-PETERSON Hysterectomy Forceps**

Curved. Longitudinal grooves, 1 x 2 teeth.

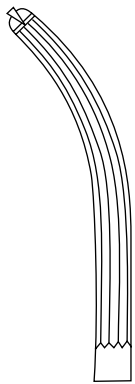

**GL3125**

Overall length 8-1/2in (21.6cm).



**GLENNER Uterine Forceps**

Overall length 8-1/4in (21cm).

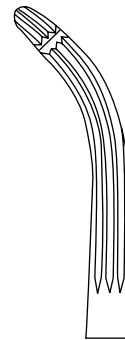

**GL3122-001**

Curved left for patient's right.

**GL3122-002**

Curved right for patient's left.



**REICH-NECHTOW Uterine Forceps**

Overall length 8-1/4in (21cm).

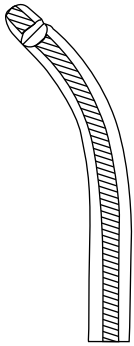

**GL3130**

Curved.

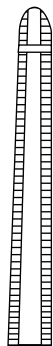

**GL3131**

Straight.



**LONG Uterine Forceps**

Slightly curved. 1 x 2 teeth.

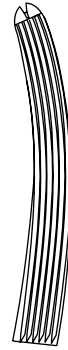

**GL3140**

Overall length  
7-1/2in (19.1cm).



**GELPI Hysterectomy Forceps**

Curved, deep serrations. 1 x 2 teeth.

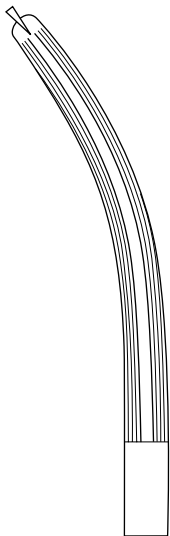

**GL3160**

Overall length  
9in (22.6cm).



**HEANEY Hysterectomy Forceps**

Overall length 12in (30.5cm).

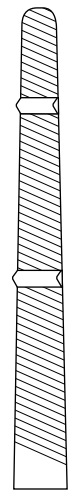

**GL3123**

Straight.

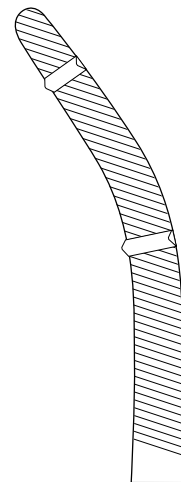

**GL3124**

Curved.



**Forceps/Clamps**

Forceps/Clamps  
Zangen/Klemmen  
Pinze/Morse  
Fórceps/Pinças  
Fórceps/Pinças  
鉗子/クランプ

**ROGERS Hysterectomy Forceps**

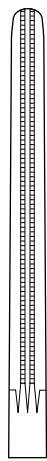

**GL3190**  
Straight.  
Overall length  
10in (25.4cm).

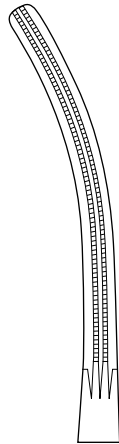

**GL3189**  
Curved.  
Overall length  
10in (25.4cm).

**GL3188**  
Straight.  
Overall length  
8-1/2in (21.6cm).

**GL3189**  
Curved.  
Overall length  
8-1/2in (21.6cm).



**Looking for a specific product?**

When you know the catalog number or the name of the product you need, you can use the index at the end of this book to direct you to the page on which the product is described. If you do not find the specific instruments you are looking for, please contact your local V. Mueller sales representative or Customer Support at **800.323.9088**.

**MASTERSON Hysterectomy Forceps**



**GL3268**  
Straight.  
Overall length  
8-1/2in (21.6cm).

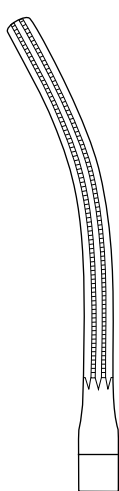

**GL3269**  
Curved.  
Overall length  
8-1/2in (21.6cm).

**GL3270**  
Straight.  
Overall length  
10in (25.4cm).

**GL3271**  
Curved.  
Overall length  
10in (25.4cm).



**CLARK Hysterectomy Clamps**

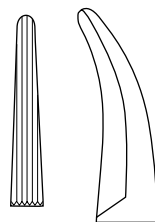

**GL3310**  
Overall length 12in (30.5cm).

**GL3311**  
Overall length 14in (35.6cm).



Z-Type Hysterectomy Clamps

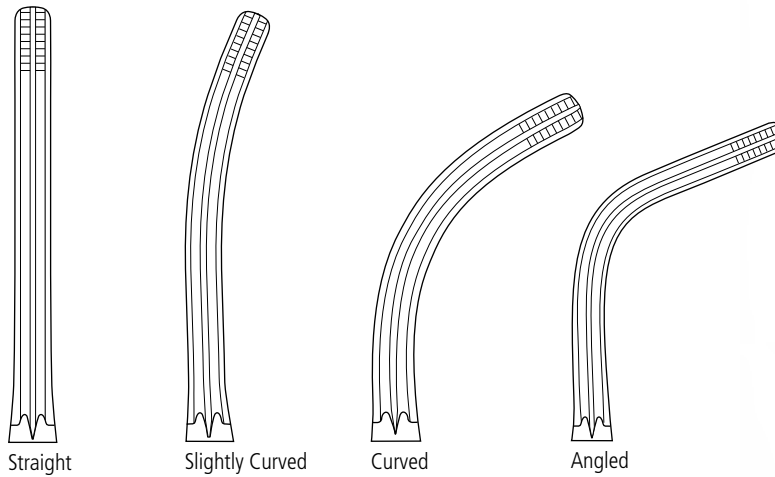

Straight Handle Overall Length	Straight Jaws	Slightly Curved Jaws	Curved Jaws	Angled Jaws
8-1/2in (21.6cm)	GL3600-001	GL3600-002	GL3600-003	GL3600-004
9-1/2in (24cm)	◆ GL3602-001	◆ GL3602-002	GL3602-003	GL3602-004
12in (30.5cm)	◆ GL3604-001	◆ GL3604-002	GL3604-003	GL3604-004
14in (35.6cm)	GL3606-001	GL3606-002	GL3606-003	GL3606-004
16in (40.6cm)	GL3608-001	GL3608-002	GL3608-003	GL3608-004

Offset Handle Overall Length	Straight Jaws	Slightly Curved Jaws	Curved Jaws	Angled Jaws
8-1/2in (21.6cm)	GL3600-005	GL3600-006	GL3600-007	GL3600-008
9-1/2in (24cm)	GL3602-005	GL3602-006	GL3602-007	GL3602-008
12in (30.5cm)	GL3604-005	GL3604-006	GL3604-007	GL3604-008
14in (35.6cm)	GL3606-005	GL3606-006	GL3606-007	GL3606-008

OB/GYN

## Forceps/Clamps

Forceps/Clamps  
Zangen/Klemmen  
Pinze/Morse  
Fórceps/Pinças  
Fórceps/Pinças  
鉗子/クランプ

### RUSSELL Uterine Forceps

Longitudinal serrations, 1 x 2 teeth.

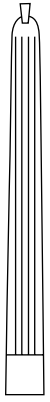

**GL3240**

Straight.  
Overall length  
8in (20.3cm).



**GL3241**

Straight.  
Overall length  
9-3/4in (24.7cm).

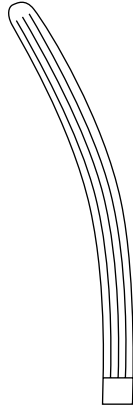

**GL3250**

Curved.  
Overall length  
8in (20.3cm).



### PHANEUF Hysterectomy Forceps

Serrated. 1 x 2 teeth.



**GL3180**

Straight.  
Overall length  
8-1/4in (21cm).

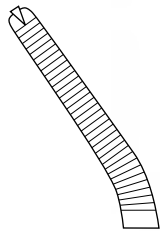

**GL3181**

Angled-on-flat.  
Overall length  
8-1/2in (21.6cm).

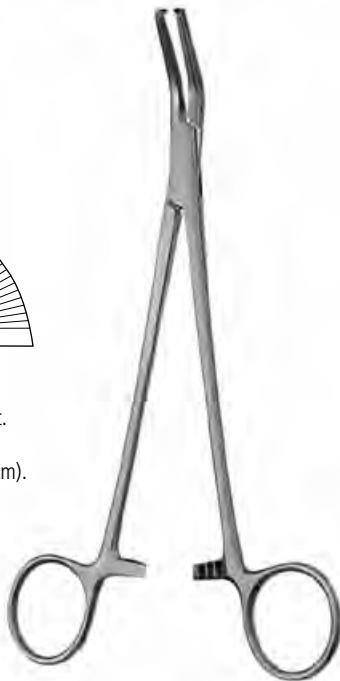

Instrument sizes, particularly overall lengths, are specified in this catalog as accurately as possible. Slight variations may occur due to metal crafting and finishing operations. Refer to the introductory pages for clarification on measurements. We reserve the right to modify products and/or services depicted herein without customer notice.



**WERTHEIM Vaginal Forceps**

Curved, serrated.

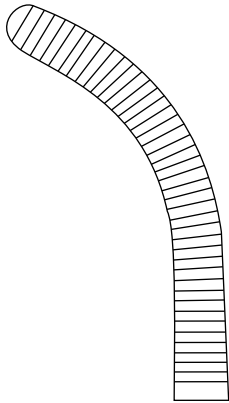

**GL3320**

Overall length  
10in (25.4cm).



**WERTHEIM-CULLEN Pedicle Forceps**

Angled, longitudinal serrations.

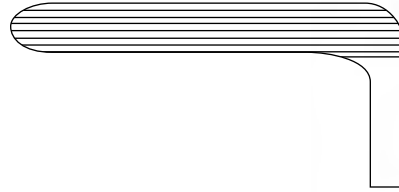

**GL3350**

Overall length  
8-1/2in (21.6cm).



**KELLY Placenta Forceps**

Curved, serrated, fenestrated jaw.

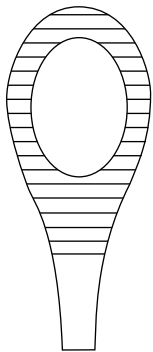

**GL5800**

Overall length  
12-1/2in (32cm).



**DE LEE Ovum Forceps**

Straight, flat, fenestrated jaw. Mirror finish.



**GL5820**

Overall length  
9-1/2in (24.1cm).



## Forceps

Forceps  
Zangen  
Pinze  
Fórceps  
Fórceps  
鉗子

### HIRST-EMMETT Placenta Forceps

Curved, fenestrated jaw.

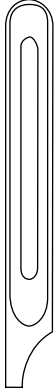

**GL5830**

Overall length  
11in (27.9cm).



### BARRETT Placenta Forceps

Fenestrated blade. Mirror finish.



**GL5840**

Overall length  
10in (25.4cm).



### BILROTH Tumor Forceps

Straight. 4 x 4 prongs.

**GL1150**

Overall length  
11in (27.9cm).



### DOYEN Tumor Screw

Mirror finish.

**GL1210**

Screw diameter  
15/16in (2.4cm).  
Overall length  
6-7/8in (17.4cm).



Sondes/Dilatateurs  
Sonden/Dilatatoren  
Sonde/Dilatatori  
Sondas/Dilatadores  
Sondas/Dilatadores  
プローブ/拡張器

**EMMETT Uterine Probe**

**GL1300**

Working length  
8-1/2in (21.6cm).  
Overall length  
11-1/2in (29.2cm).



**SIMS Uterine Sounds**

Overall length 14-1/4in (36.2cm).

**GL1310**

Without graduations.

◆ **GL1320**  
Graduated in centimeters.



**SIMPSON Uterine Sound**

**GL1330**

Graduated in inches.  
Working length  
9in (22.9cm).  
Overall length  
13-1/2in (34.3cm).



**HEGAR Uterine Dilators**

Solid, single-ended. Mirror finish.  
Overall length 7-1/4in (18.5cm).

**GL1401**

Set of 26.  
Single ended.  
One of each size.

**GL1401-001**

Size 1mm.

**GL1401-002**

Size 2mm.

**GL1401-003**

Size 3mm.

**GL1401-004**

Size 4mm.

**GL1401-005**

Size 5mm.

**GL1401-006**

Size 6mm.

**GL1401-007**

Size 7mm.

**GL1401-008**

Size 8mm.

**GL1401-009**

Size 9mm.

**GL1401-010**

Size 10mm.

**GL1401-011**

Size 11mm.

**GL1401-012**

Size 12mm.

**GL1401-013**

Size 13mm.

**GL1401-014**

Size 14mm.

**GL1401-015**

Size 15mm.

**GL1401-016**

Size 16mm.

**GL1401-017**

Size 17mm.

**GL1401-018**

Size 18mm.

**GL1401-019**

Size 19mm.

**GL1401-020**

Size 20mm.

**GL1401-021**

Size 21mm.

**GL1401-022**

Size 22mm.

**GL1401-023**

Size 23mm.

**GL1401-024**

Size 24mm.

**GL1401-025**

Size 25mm.

**GL1401-026**

Size 26mm.



**HEGAR Uterine Dilators**

Hollow, double-ended. Mirror finish.  
Overall length 8in (20.3cm).

◆ **GL1411**

Set of eight. One of each size.

**GL1411-001**

Size 3-4mm.

**GL1411-002**

Size 5-6mm.

**GL1411-003**

Size 7-8mm.

**GL1411-004**

Size 9-10mm.

**GL1411-005**

Size 11-12mm.

**GL1411-006**

Size 13-14mm.

**GL1411-007**

Size 15-16mm.

**GL1411-008**

Size 17-18mm.



## Dilators/Curettes

Dilatateurs/Curettes  
 Dilatoren/Küretten  
 Dilatori/Curette  
 Diladores/Curetas  
 Diladores/Curetas  
 拡張器/キュレット

### PRATT Uterine Dilators

Solid, double-ended. Mirror finish. Overall length 11-3/8in (28.9cm).

#### ◆ GL1451

Each dilator in two sizes, French scale as follows:  
 13-15, 17-19, 21-23, 25-27, 29-31, 33-35, 37-39, 41-43.  
 Set of eight.

#### GL1450-001

Size 13-15Fr.

#### GL1450-002

Size 17-19Fr.

#### GL1450-003

Size 21-23Fr.

#### GL1450-004

Size 25-27Fr.

#### GL1450-005

Size 29-31Fr.

#### GL1450-006

Size 33-35Fr.

#### GL1450-007

Size 37-39Fr.

#### GL1450-008

Size 41-43Fr.



### HANK Uterine Dilators

Double-ended. Mirror finish. Overall length 10-1/2in (26.7cm).

#### ◆ GL1460

American. Solid. Each dilator in two sizes, scale as follows:  
 9-10, 11-12, 13-14, 15-16,  
 17-18, 19-20. Set of six.

#### GL1461-001

Size 9-10.

#### GL1461-002

Size 11-12.

#### GL1461-003

Size 13-14.

#### GL1461-004

Size 15-16.

#### GL1461-005

Size 17-18.

#### GL1461-006

Size 19-20.



### HANK-BRADLEY Uterine Dilators

Cannulated. Double-ended. Mirror finish. Overall length 10-1/2in (26.7cm).

#### GL1471-001

Size 9-10.

#### GL1471-002

Size 11-12.

#### GL1471-003

Size 13-14.

#### GL1471-004

Size 15-16.

#### GL1471-005

Size 17-18.

#### GL1471-006

Size 19-20.



### SIMS Uterine Curettes

Sharp. Malleable. Mirror and Satin finish. Overall length 11in (27.9cm).



GL1600-00  
Size 00.



GL1600-0  
Size 0.



GL1600-001  
Size 1.



◆ GL1600-002  
Size 2.



GL1600-003  
Size 3.



GL1600-004  
Size 4.

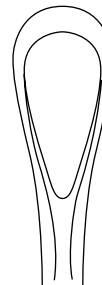

GL1600-005  
Size 5.

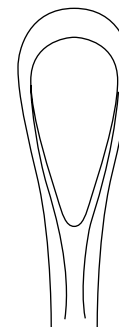

GL1600-006  
Size 6.



**THOMAS Uterine Curettes**

Blunt. Malleable. Overall length 11in (27.9cm).



**GL1610-001**

Size 1.



**GL1610-003**

Size 3.

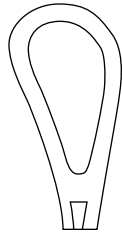

**GL1610-005**

Size 5.

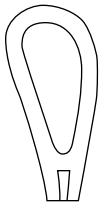

**GL1610-002**

Size 2.



**GL1610-004**

Size 4.



**GL1610-006**

Size 6.



**BALLENTINE Uterine Curette**

**GL1620**

Double-ended, size 2-4, malleable. Overall length 13-5/8in (34.6cm).



**HUNTER Large Uterine Curette**

Mirror and Satin finish.

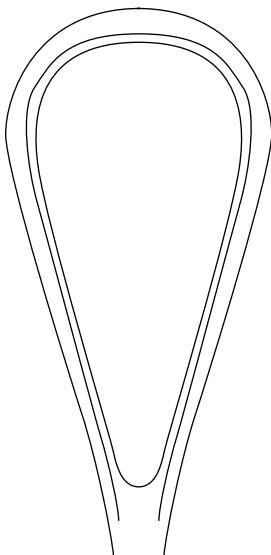

◆ **GL1625**

Blade 3cm wide.  
Working length 8in (20.3cm).



**RECAMIER Uterine Curettes**

Sharp. Overall length 11in (27.9cm).



**GL1630-001**

Size 1.



**GL1630-003**

Size 3.

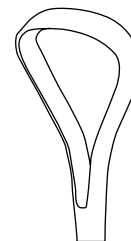

**GL1630-005**

Size 5.



**GL1630-002**

Size 2.



**GL1630-004**

Size 4.

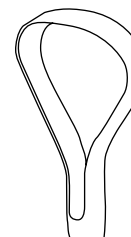

**GL1630-006**

Size 6.



**Curettes**

Curettes  
Küretten  
Curette  
Curetas  
Curetaz  
キュレット

**HEANEY Uterine Curette**

Serrated cutting edge, malleable.  
Mirror and Satin finish.



**GL1700**

Overall length  
9-5/8in (24.4cm).



**KELLY-GRAY Uterine Curettes**

Serrated cutting edge.  
Overall length 9-1/2in (24.1cm).



**GL1701**

Size 1.



**GL1703**

Size 3.



**GL1702**

Size 2.



**GL1704**

Size 4.



**RANDALL Endometrial Biopsy Suction Curettes**

Luer lock hub.

**GL1740**

Outside diameter 4mm.  
Overall length  
9-1/4in (23.5cm).



**NOVAK Endometrial Biopsy Suction Curette**

Curved, with Luer lock hub.

**GL1750**

Overall length  
9-1/4in (23.5cm).



**KEVORKIAN-YOUNGE Endocervical Biopsy Curette**

Slightly curved.



◆ **GL1775**

Overall length  
12in (30.5cm).



**GARCIA Endometrial Biopsy Curette**

Mirror and Satin finish.

**GL1796**

Window 2.3mm x 3.5mm.  
Working length  
7-3/4in (19.7cm).



**LAUFE Uterine Polyp Forcep**

Curved, serrated jaws. Overall length 8in (20.3cm).

**GL1820**



**OVERSTREET Endometrial Polyp Forceps**

Hollow, fenestrated jaw.



**GL1800-1**

Overall length 9-1/4in (23.5cm).



**FLETCHER-VAN DOREN Uterine Polyp, Sponge Holding Forceps**

Double-curved.

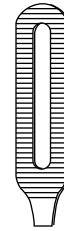

◆ **GL1805**

Overall length 9-1/2in (24.1cm).



**GAYLOR Uterine Specimen Forceps**

Angled, sharp, cup-shaped jaws.



**GL1902**

Overall length 9in (22.9cm).



**THOMS-GAYLOR Uterine Biopsy Punch**

Angled, sharp, cup-shaped jaws.

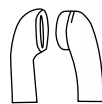

**GL1900**

Overall length 9in (22.9cm).

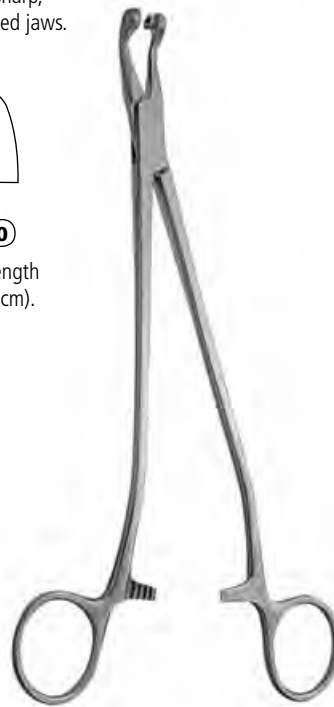

**SCHUBERT Uterine Biopsy Punch Forceps**

Overall length 8-1/2in (21.6cm).



**GL1910**

Straight.

**GL1920**

Curved-on-side.





**Forceps**

Forceps  
Zangen  
Pinze  
Fórcps  
Fórcps  
鉗子

**KEVORKIAN-YOUNGE Biopsy Forceps**

Narrow jaws. Fine teeth in lower jaw; serrations on sides. Jaws open to almost 90°, with sharp cutting edges.



- ◆ **GL1925**  
Cup size 8.5mm x 3.5mm wide.  
Overall length 10in (25.4cm).

**EPPENDORFER Cervical Biopsy Forceps**



- ◆ **GL1926**  
3.5mm x 8mm cup.  
Working length 8-1/2in (21.6cm).

**TISCHLER Cervical Biopsy Punch Forceps**

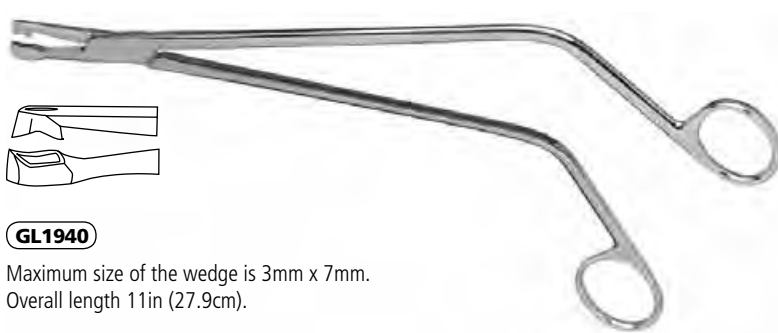

- ◆ **GL1940**  
Maximum size of the wedge is 3mm x 7mm.  
Overall length 11in (27.9cm).

**TISCHLER Cervical Biopsy Punch Forceps**

Alligator-type.

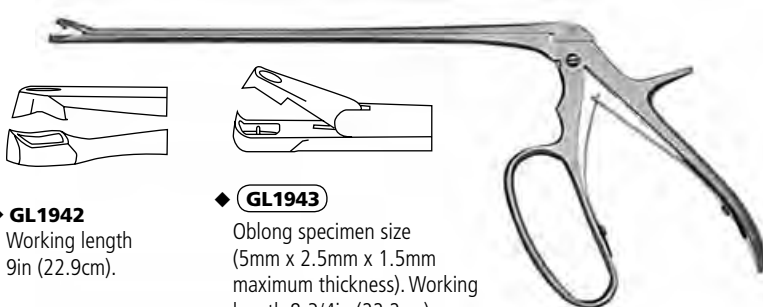

- ◆ **GL1942**  
Working length 9in (22.9cm).
- ◆ **GL1943**  
Oblong specimen size (5mm x 2.5mm x 1.5mm maximum thickness). Working length 8-3/4in (22.2cm).

**VAN DOREN Uterine Biopsy Punch Forceps**

Angled.



- ◆ **GL1930**  
Overall length 10in (25.4cm).

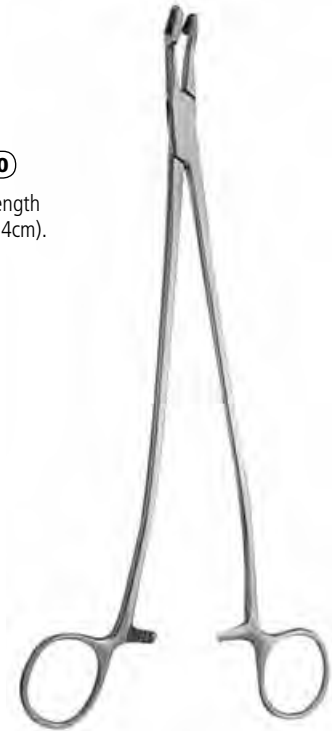

Forceps/Canules  
Zangen/Kanülen  
Pinze/Cannulae  
Fórceps/Cânulas  
Fórceps/Cânulas  
鉗子/カニューレ

**TISCHLER Cervical Biopsy Punch Forceps**

Rotatable shaft. Working length 9in (22.9cm). Overall length 12in (30.5cm).



**GL1945**

3mm x 7mm bite.

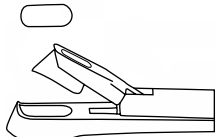

◆ **GL1946**

2mm x 4mm bite.

**FLEMING Conization Instrument**

Adjustable blade, from straight to 7mm arc. Cuts left or right. Matte and Mirror finish.



**GL1965**

Overall length 10in (25.4cm).

**GL1966**

Replacement Conization Blades for GL1965. Single use, non-sterile. Six per package.



**KAHN Uterine Trigger Cannula**

Mirror and Satin finish.

◆ **GL2360**

Includes two flexible extension tips, standard and giant-size acorn tips, acorn stop-collar. Overall length 12-5/8in (32cm).

**GL2360-001**

KAHN Silicone Rubber Acorn Tip only. Giant size. Overall length 1-1/2in (3.8cm).

**GL2360-002**

Flexible Extension Tip only.



**JARCHO Self-Retaining Uterine Cannula**

**GL2375**

Cannula. Overall length 8-1/4in (21cm).

**GL2375-001**

Tenaculum Holder for GL2375. Overall length 2-1/4in (5.7cm).

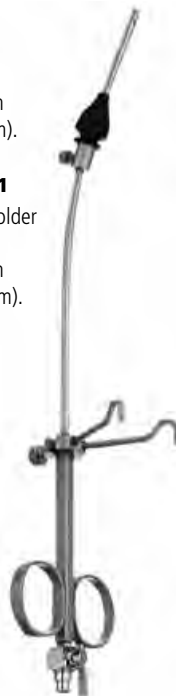

**NEAL Fallopian Cannula**

Useful in fallopian tube patency testing. Mirror finish. Stainless steel body.

**GL2400**

Overall length 11-1/2in (29.2cm).



**Silicone Rubber Acorn**

Attaches to syringe or irrigator for bladder and urethral irrigations.

**GU4360**

Standard size. Overall length 1-1/16in (2.7cm).



**Needles/Forceps**

Aiguilles/Forceps  
Nadeln/Zangen  
Aghi/Pinze  
Agujas/Fórceps  
Aguilhas/Fórceps  
針/鉗子

**COLLYER Pelvimeter**

**GL5000**

Graduated in inches and centimeters. External measurements.



**V. Mueller® Paracervical and Pudendal Nerve Block Needle**

A stud pin on the needle, just ahead of its Luer lock hub, fits in a slot in the proximal end of the protective sheath to hold the needle safely retracted until it is on target,

**GL5150**

Overall length retracted 8in (20.3cm).

**GL5151**

Replacement Needle only for GL5150. Mirror and Satin finish.



**IOWA-Type Trumpet Needle Guide Block.**

Mirror finish.

**GL5155**



**IOWA Membrane Puncturing Forceps**



**GL5260**

Overall length 10in (25.4cm).



**SIMPSON Obstetrical Forceps**

Mirror and Satin finish.

**GL5300**

Overall length 14in (36cm).

**GL5301**

Overall length 12in (30.5cm).



**DE LEE Obstetrical Forceps**

Mirror and Satin finish.

**GL5320-4**

Overall length 12in (30.5cm).



**KIELLAND Obstetrical Forceps**

Mirror finish.

**GL5510-1**

Overall length  
16in (40.6cm).



**LUIKART-KIELLAND Obstetrical Forceps**

Solid LUIKART blades.  
Mirror finish.

**GL5520**

Overall length  
16-1/2in (41.9cm).



**McLANE-TUCKER Obstetrical Forceps**

Overall length  
16-1/4in (41.3cm).

**GL5525**

Solid LUIKART blades.



**PIPER Obstetrical Forceps**

Mirror and Satin finish.

**GL5500**

Overall length  
18in (46.0cm).



**BILL Traction Handle**

**GL5600**

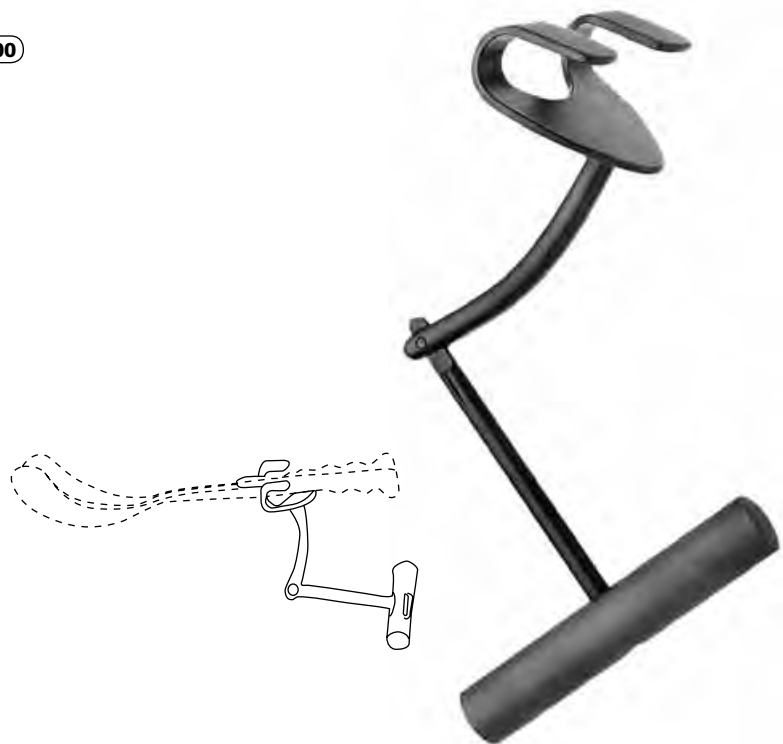

**Forceps/Scissors**

Forceps/Ciseaux  
Zangen/Scheren  
Pinze/Forbici  
Fórceps/Tijeras  
Fórceps/Tesoura  
鉗子/鉗

**MOGEN Circumcision Clamp**

◆ **GL7021**



**Fallopian Tube Forceps**

**GL4012**

Small. Overall length  
8-1/8in (20.6cm).



**Retracting Rods**

Teflon® tip.

**GL4110-001**

Size 1mm. Overall length  
7-5/8in (19.4cm).

**GL4110-002**

Size 3.5mm. Overall length  
7-3/4in (19.7cm).

**GL4110-003**

Size 5mm. Overall length  
7-3/4in (19.7cm).



**Tubal Scissors**

Straight. Round handle.

**GL4318**

Overall length  
7in (18cm).



**Micro-Tubal Scissors**

Matte and Mirror finish.  
Overall length 7in (17.8cm).



**GL4321**

Curved.

**GL4322**

Curved,  
serrated tips.



**GL4323**

Straight.



Écarteurs/Crochets/Divers  
 Wundspreizer/Retraktoren/Haken/Verschiedenes  
 Divaricatori/Uncini/Varie  
 Separadores/Ganchos/Varios  
 Retratores/Ganchos/Diversos  
 リトラクター/フック/その他

**LATERAL Vaginal Retractor**

Blades fit inside a vaginal speculum. Ratchet handle.

**GL495**

Overall length  
 11in (28cm).



**EMMETT Hooks Quick Release**

Overall length 9in (22.9cm).



**GL805**

No. 1.



**GL806**

No. 2.



**Inflated Rubber Pessaries**

No Latex.

**GL2670-001**

Size 2-1/4in (5.7cm).

**GL2670-002**

Size 2-1/2in (6.4cm).

**GL2670-003**

Size 2-3/4in (7cm).

**GL2670-004**

Size 3in (7.6cm).

**GL2670-005**

Size 3-1/4in (8.3cm).



**BETHEA Sheet Holders**

These are a convenient and comfortable means of holding sheets and drapes during examination and treatment. Mirror finish.

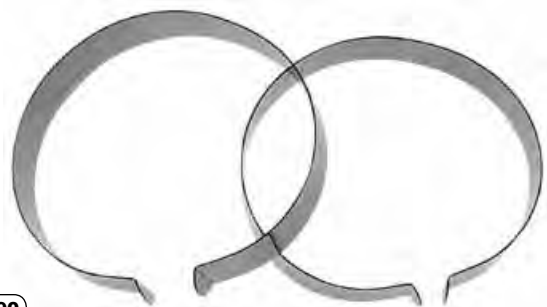

**GL5190**

Pair.

OB/GYN

